

SERVICE MANUAL

T6.125 / T6.145 / T6.155 / T6.165 / T6.175 / T6.180
T6.145 AutoCommand™ / T6.155 AutoCommand™
T6.165 AutoCommand™ / T6.175 AutoCommand™
Tier 4B (final)
Tractor

Part number 47938738
1st edition English
October 2015





SERVICE MANUAL

**T6.125 , T6.145 AutoCommand™ , T6.145 , T6.155 AutoCommand™ , T6.155 ,
T6.165 AutoCommand™ , T6.165 , T6.175 AutoCommand™ , T6.175 , T6.180**

Link Product / Engine

Product	Market Product	Engine
T6.145 AutoCommand™	North America	F4DFE4134*B005
T6.155 AutoCommand™	North America	F4DFE4133*B007
T6.165 AutoCommand™	North America	F4DFE4132*B005
T6.175 AutoCommand™	North America	F4DFE4131*B007
T6.125	North America	F4DFE414D*B001
T6.145	North America	F4DFE4134*B006
T6.155	North America	F4DFE4133*B008
T6.165	North America	F4DFE4132*B006
T6.175	North America	F4DFE4131*B008
T6.180	North America	F4DFE6132*B007

Contents

INTRODUCTION

Engine	10
[10.001] Engine and crankcase	10.1
[10.216] Fuel tanks	10.2
[10.202] Air cleaners and lines	10.3
[10.254] Intake and exhaust manifolds and muffler	10.4
[10.500] Selective Catalytic Reduction (SCR) exhaust treatment.....	10.5
[10.400] Engine cooling system	10.6
[10.414] Fan and drive	10.7
[10.310] Aftercooler.....	10.8
[10.304] Engine lubrication system.....	10.9
Clutch	18
[18.112] Slip clutch or flywheel damper	18.1
Transmission	21
[21.111] Semi-Powershift transmission	21.1
[21.133] Semi-Powershift transmission external controls	21.2
[21.103] Semi-Powershift transmission lubrication system.....	21.3
[21.152] Semi-Powershift transmission internal components	21.4
[21.504] Continuously Variable Transmission (CVT)	21.5
[21.505] Continuously Variable Transmission (CVT) external controls.....	21.6
[21.506] Continuously Variable Transmission (CVT) lubrication system	21.7
[21.507] Continuously Variable Transmission (CVT) internal components.....	21.8
[21.160] Creeper	21.9
[21.166] Overdrive.....	21.10
Four-Wheel Drive (4WD) system	23
[23.202] Electro-hydraulic control	23.1

[23.314] Drive shaft.....	23.2
Front axle system	25
[25.100] Powered front axle	25.1
[25.102] Front bevel gear set and differential	25.2
[25.108] Final drive hub, steering knuckles, and shafts	25.3
[25.122] Axle suspension control.....	25.4
Rear axle system.....	27
[27.100] Powered rear axle.....	27.1
[27.106] Rear bevel gear set and differential.....	27.2
[27.120] Planetary and final drives	27.3
Power Take-Off (PTO).....	31
[31.104] Rear electro-hydraulic control.....	31.1
[31.114] Two-speed rear Power Take-Off (PTO)	31.2
[31.142] Front Power Take-Off (PTO) control	31.3
[31.146] Front Power Take-Off (PTO)	31.4
Brakes and controls	33
[33.202] Hydraulic service brakes	33.1
[33.110] Parking brake or parking lock	33.2
[33.220] Trailer brake hydraulic control.....	33.3
[33.224] Trailer brake pneumatic control	33.4
[33.204] Front axle brake	33.5
Hydraulic systems.....	35
[35.000] Hydraulic systems.....	35.1
[35.300] Reservoir, cooler, and filters.....	35.2
[35.104] Fixed displacement pump.....	35.3
[35.106] Variable displacement pump	35.4
[35.105] Charge pump.....	35.5
[35.322] Regulated/Low pressure system	35.6

[35.204] Remote control valves	35.7
[35.220] Auxiliary hydraulic pump	35.8
[35.114] Three-point hitch control valve	35.9
[35.116] Three-point hitch cylinder	35.10
[35.160] Front hitch controls and lines	35.11
Hitches, drawbars, and implement couplings.....	37
[37.120] Rear three-point hitch linkage.....	37.1
Frames and ballasting	39
[39.100] Frame	39.1
Steering.....	41
[41.101] Steering control	41.1
[41.106] Tie rods.....	41.2
[41.200] Hydraulic control components.....	41.3
[41.206] Pump	41.4
[41.216] Cylinders	41.5
[41.432] Autoguidance steering	41.6
Wheels	44
[44.511] Front wheels.....	44.1
[44.520] Rear wheels	44.2
Cab climate control	50
[50.100] Heating	50.1
[50.104] Ventilation	50.2
[50.200] Air conditioning.....	50.3
Electrical systems	55
[55.000] Electrical system	55.1
[55.100] Harnesses and connectors.....	55.2
[55.015] Engine control system.....	55.3

[55.301] Alternator	55.4
[55.302] Battery.....	55.5
[55.014] Engine intake and exhaust system.....	55.6
[55.988] Selective Catalytic Reduction (SCR) electrical system	55.7
[55.640] Electronic modules	55.8
[55.024] Transmission control system	55.9
[55.020] Transmission speed sensors.....	55.10
[55.021] Transmission pressure sensors	55.11
[55.022] Transmission temperature sensors	55.12
[55.023] Transmission position sensors	55.13
[55.048] Rear Power Take-Off (PTO) control system	55.14
[55.031] Parking brake electrical system	55.15
[55.512] Cab controls.....	55.16
[55.035] Remote control valve electric control	55.17
[55.051] Cab Heating, Ventilation, and Air-Conditioning (HVAC) controls.....	55.18
[55.050] Heating, Ventilation, and Air-Conditioning (HVAC) control system.....	55.19
[55.047] Steering control system	55.20
[55.130] Rear three-point hitch electronic control system	55.21
[55.911] Global Positioning System (GPS)	55.22
[55.405] External lighting switches and relays	55.23
[55.510] Cab or platform harnesses and connectors.....	55.24
[55.408] Warning indicators, alarms, and instruments	55.25
[55.DTC] FAULT CODES.....	55.26
Platform, cab, bodywork, and decals	90
[90.150] Cab.....	90.1
[90.100] Engine hood and panels	90.2



INTRODUCTION

Contents

INTRODUCTION

Foreword - Important notice regarding equipment servicing	3
Foreword - How to use and navigate through this manual	4
Safety rules	9
Safety rules - Ecology and the environment	10
Basic instructions - Shop and assembly	11
Torque	13
Conversion factors	15
Consumables Lubrications and Coolants	16
Capacities	17

Foreword - Important notice regarding equipment servicing

All repair and maintenance work listed in this manual must be carried out only by qualified dealership personnel, strictly complying with the instructions given, and using, whenever possible, the special tools.

Anyone who performs repair and maintenance operations without complying with the procedures provided herein shall be responsible for any subsequent damages.

The manufacturer and all the organizations of its distribution chain, including - without limitation - national, regional, or local dealers, reject any responsibility for damages caused by parts and/or components not approved by the manufacturer, including those used for the servicing or repair of the product manufactured or marketed by the manufacturer. In any case, no warranty is given or attributed on the product manufactured or marketed by the manufacturer in case of damages caused by parts and/or components not approved by the manufacturer.

The manufacturer reserves the right to make improvements in design and changes in specifications at any time without notice and without incurring any obligation to install them on units previously sold. Specifications, descriptions, and illustrative material herein are as accurate as known at time of publication but are subject to change without notice.

In case of questions, refer to your NEW HOLLAND Sales and Service Networks.

Foreword - How to use and navigate through this manual

This manual has been produced by a new technical information system. This new system is designed to deliver technical information electronically through web delivery (eTIM), DVD, and paper manuals. A coding system called SAP has been developed to link the technical information to other Product Support functions, e.g., Warranty.

Technical information is written to support the maintenance and service of the functions or systems on a customer's machine. When a customer has a concern on their machine it is usually because a function or system on their machine is not working at all, is not working efficiently, or is not responding correctly to their commands. When you refer to the technical information in this manual to resolve that customer's concern, you will find all the information classified using the SAP coding, according to the functions or systems on that machine. Once you have located the technical information for that function or system, you will then find all the mechanical, electrical or hydraulic devices, components, assemblies, and sub assemblies for that function or system. You will also find all the types of information that have been written for that function or system: the technical data (specifications), the functional data (how it works), the diagnostic data (fault codes and troubleshooting), and the service data (remove, install adjust, etc.).

By integrating SAP coding into technical information, you will be able to search and retrieve just the right piece of technical information you need to resolve that customer's concern on his machine. This is made possible by attaching 3 categories to each piece of technical information during the authoring process.

The first category is the Location, the second category is the Information Type and the third category is the Product:

- LOCATION - the component or function on the machine, that the piece of technical information is going to describe (e.g., Fuel tank).
- INFORMATION TYPE - the piece of technical information that has been written for a particular component or function on the machine (e.g., Capacity would be a type of Technical Data describing the amount of fuel held by the fuel tank).
- PRODUCT - the model for which the piece of technical information is written.

Every piece of technical information will have those three categories attached to it. You will be able to use any combination of those categories to find the right piece of technical information you need to resolve that customer's concern on their machine.

That information could be:

- the procedure for how to remove the cylinder head
- a table of specifications for a hydraulic pump
- a fault code
- a troubleshooting table
- a special tool

Manual content

This manual is divided into Sections. Each Section is then divided into Chapters. Contents pages are included at the beginning of the manual, then inside every Section and inside every Chapter. An alphabetical Index is included at the end of each Chapter. Page number references are included for every piece of technical information listed in the Chapter Contents or Chapter Index.

Each Chapter is divided into four Information types:

- Technical Data (specifications) for all the mechanical, electrical or hydraulic devices, components, assemblies or sub-assemblies.
- Functional Data (how it works) for all the mechanical, electrical or hydraulic devices, components, assemblies or sub-assemblies.
- Diagnostic Data (fault codes, electrical and hydraulic troubleshooting) for all the mechanical, electrical or hydraulic devices, components, assemblies or sub-assemblies.
- Service Data (remove disassemble, assemble, install) for all the mechanical, electrical or hydraulic devices, components, assemblies or sub-assemblies.

Sections

Sections are grouped according to the main functions or a systems on the machine. Each Section is identified by a number (00, 35, 55, etc.). The Sections included in the manual will depend on the type and function of the machine that the manual is written for. Each Section has a Contents page listed in alphabetic/numeric order. This table illustrates which Sections could be included in a manual for a particular product.

SECTION	PRODUCT					
	Tractors					
	Vehicles with working arms: backhoes, excavators, skid steers,					
	Combines, forage harvesters, balers,					
	Seeding, planting, floating, spraying equipment,					
Mounted equipment and tools,						
00 - Maintenance	X	X	X	X	X	
05 - Machine completion and equipment	X	X	X	X	X	
10 - Engine	X	X	X	X		
14 - Main gearbox and drive	X	X	X	X		
18 - Clutch	X	X	X			
21 - Transmission	X	X	X	X		
23 - Four wheel drive (4WD) system	X	X	X	X		
25 - Front axle system	X	X	X	X		
27 - Rear axle system	X	X	X	X		
29 - Hydrostatic drive	X	X	X	X		
31 - Power Take-Off (PTO)	X		X			
33 - Brakes and controls	X	X	X	X		
35 - Hydraulic systems	X	X	X	X		
36 - Pneumatic system	X	X	X	X		
37 - Hitches, drawbars and implement couplings	X		X	X		
39 - Frames and ballasting	X	X	X	X	X	
41 - Steering	X	X	X	X		
44 - Wheels	X	X	X	X		
46 - Steering clutches						
48 - Tracks and track suspension	X	X	X			
50 - Cab climate control	X	X	X	X		
55 - Electrical systems	X	X	X	X	X	
56 - Grape harvester shaking						
58 - Attachments/headers			X			
60 - Product feeding			X			

INTRODUCTION

61 - Metering system				X	
62 - Pressing - Bale formation			X		
63 - Chemical applicators				X	
64 - Chopping			X		
66 - Threshing			X		
68 - Tying/Wrapping/Twisting			X		
69 - Bale wagons					
70 - Ejection			X		
71 - Lubrication system	X	X	X	X	X
72 - Separation			X		
73 - Residue handling			X		
74 - Cleaning			X		
75 - Soil preparation/Finishing					
76 - Secondary cleaning / Destemmer					
77 - Seeding				X	
78 - Spraying				X	
79 - Planting				X	
80 - Crop storage / Unloading			X		
82 - Front loader and bucket	X	X			
83 - Telescopic single arm	X	X			
84 - Booms, dippers and buckets	X	X			
86 - Dozer blade and arm	X	X			
88 - Accessories	X	X	X	X	X
89 - Tools	X	X	X	X	X
90 - Platform, cab, bodywork and decals	X	X	X	X	

Chapters

Each Chapter is identified by a number e.g. Engine - Engine and crankcase - 10.001. The first number is identical to the Section number i.e. Chapter 10.001 is inside Section 10, Engine. The second number is representative of the Chapter contained within the Section.

CONTENTS

The Chapter Contents lists all the technical data (specifications), functional data (how it works), diagnostic data (fault codes and troubleshooting), and service data (remove, install, adjust, etc.), that have been written in that Chapter for that function or system on the machine.

Contents

	ENGINE	
	ENGINE - Engine and crankcase – 10.001	
TECHNICAL DATA		
ENGINE - Engine and crankcase - General specification (10.001 - D.40.A.10)		4
FUNCTIONAL DATA		
ENGINE - Engine and crankcase - Dynamic description (10.001 - C.30.A.10)		6
SERVICE		
ENGINE - Engine and crankcase - Remove (10.001 -F.10.A.10)		8
DIAGNOSTIC		
ENGINE - Engine and crankcase - Troubleshooting (10.001 - G.40.A.10)		10

INDEX

The Chapter Index lists in alphabetical order all the types of information (called information units) that have been written in that Chapter for that function or system on the machine.

Index

	ENGINE - 10	
	ENGINE	
ENGINE - Engine and crankcase - Dynamic description (10.001 - C.30.A.10)		6
ENGINE - Engine and crankcase - General specification (10.001 - D.40.A.10)		4
ENGINE - Engine and crankcase - Remove (10.001 -F.10.A.10)		8
ENGINE - Engine and crankcase - Troubleshooting (10.001 - G.40.A.10)		10

Information units and information search

Each chapter is composed of information units. Each information unit has the SAP code shown in parentheses. This indicates the function and type of information in that information unit. Each information unit has a page reference within that Chapter. The information units provide a quick and easy way to find just the right piece of technical information you are looking for.

Example information unit	Engine block cover - Front – Remove (10.102.AP.01 - F.10.A.10)					
Information Unit SAP code	10	102	AK	01	F	10.A.10
SAP code classification	Engine	Pan and covers	Engine block cover	Front	Service data	Remove cover

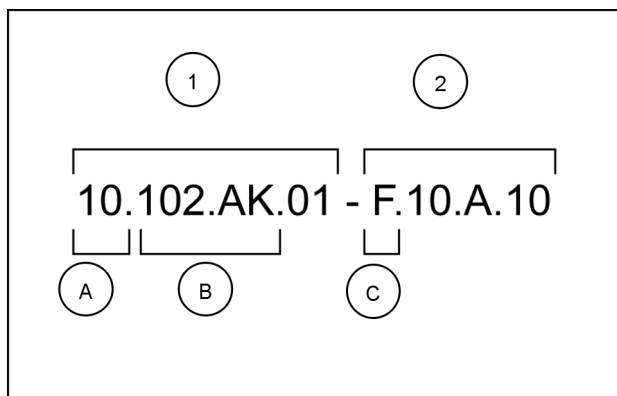

NHIL12GEN0070A 1

Navigate to the correct information unit you are searching for by identifying the function and information type from the SAP code.

- **(1)** Location and **(2)** Information type.
- **(A)** corresponds to the sections of the service manual.
(B) corresponds to the chapters of the service manual. After **(B)** there may be some additional information. In this case it shows “.01”, which represents the “Front” block cover. These options may be front/rear, left/right, hydraulic/mechanical etc.
(C) corresponds to the type of information listed in the chapter contents: Technical Data, Functional Data, Diagnostic, or Service.
(A) and **(B)** are also shown in the page numbering on the page footer.
THE REST OF THE CODING IS NOT LISTED IN ALPHANUMERIC ORDER IN THIS MANUAL.
- You will find a table of contents at the beginning and end of each section and chapter.
You will find an alphabetical index at the end of each chapter.
- By referring to **(A)**, **(B)** and **(C)** of the coding, you can follow the contents or index (page numbers) and quickly find the information you are looking for.

Page header and footer

The page header will contain the following references:

- Section and Chapter description

The page footer will contain the following references:

- Publication number for that Manual.
- Version reference for that publication.
- Publication date
- Section, chapter, and page reference e.g. 10.102 / 9

Safety rules

Personal safety





This is the safety alert symbol. It is used to alert you to potential personal injury hazards. Obey all safety messages that follow this symbol to avoid possible death or injury.

Throughout this manual you will find the signal words DANGER, WARNING, and CAUTION followed by special instructions. These precautions are intended for the personal safety of you and those working with you.

Read and understand all the safety messages in this manual before you operate or service the machine.

 DANGER indicates a hazardous situation that, if not avoided, will result in death or serious injury.

 WARNING indicates a hazardous situation that, if not avoided, could result in death or serious injury.

 CAUTION indicates a hazardous situation that, if not avoided, could result in minor or moderate injury.

FAILURE TO FOLLOW DANGER, WARNING, AND CAUTION MESSAGES COULD RESULT IN DEATH OR SERIOUS INJURY.

Machine safety

NOTICE: Notice indicates a situation that, if not avoided, could result in machine or property damage.

Throughout this manual you will find the signal word Notice followed by special instructions to prevent machine or property damage. The word Notice is used to address practices not related to personal safety.

Information

NOTE: Note indicates additional information that clarifies steps, procedures, or other information in this manual.

Throughout this manual you will find the word Note followed by additional information about a step, procedure, or other information in the manual. The word Note is not intended to address personal safety or property damage.

Safety rules - Ecology and the environment

Soil, air, and water quality is important for all industries and life in general. When legislation does not yet rule the treatment of some of the substances that advanced technology requires, sound judgment should govern the use and disposal of products of a chemical and petrochemical nature.

Familiarize yourself with the relative legislation applicable to your country, and make sure that you understand this legislation. Where no legislation exists, obtain information from suppliers of oils, filters, batteries, fuels, anti-freeze, cleaning agents, etc., with regard to the effect of these substances on man and nature and how to safely store, use, and dispose of these substances.

Helpful hints

- Avoid the use of cans or other inappropriate pressurized fuel delivery systems to fill tanks. Such delivery systems may cause considerable spillage.
- In general, avoid skin contact with all fuels, oils, acids, solvents, etc. Most of these products contain substances that may be harmful to your health.
- Modern oils contain additives. Do not burn contaminated fuels and or waste oils in ordinary heating systems.
- Avoid spillage when you drain fluids such as used engine coolant mixtures, engine oil, hydraulic fluid, brake fluid, etc. Do not mix drained brake fluids or fuels with lubricants. Store all drained fluids safely until you can dispose of the fluids in a proper way that complies with all local legislation and available resources.
- Do not allow coolant mixtures to get into the soil. Collect and dispose of coolant mixtures properly.
- The air-conditioning system contains gases that should not be released into the atmosphere. Consult an air-conditioning specialist or use a special extractor to recharge the system properly.
- Repair any leaks or defects in the engine cooling system or hydraulic system immediately.
- Do not increase the pressure in a pressurized circuit as this may lead to a component failure.
- Protect hoses during welding. Penetrating weld splatter may burn a hole or weaken hoses, allowing the loss of oils, coolant, etc.

Battery recycling

Batteries and electric accumulators contain several substances that can have a harmful effect on the environment if the batteries are not properly recycled after use. Improper disposal of batteries can contaminate the soil, groundwater, and waterways. NEW HOLLAND strongly recommends that you return all used batteries to a NEW HOLLAND dealer, who will dispose of the used batteries or recycle the used batteries properly. In some countries, this is a legal requirement.



Mandatory battery recycling

NOTE: *The following requirements are mandatory in Brazil.*

Batteries are made of lead plates and a sulfuric acid solution. Because batteries contain heavy metals such as lead, CONAMA Resolution 401/2008 requires you to return all used batteries to the battery dealer when you replace any batteries. Do not dispose of batteries in your household garbage.

Points of sale are obliged to:

- Accept the return of your used batteries
- Store the returned batteries in a suitable location
- Send the returned batteries to the battery manufacturer for recycling

Basic instructions - Shop and assembly

Shimming

For each adjustment operation, select adjusting shims and measure the adjusting shims individually using a micrometer, then add up the recorded values. Do not rely on measuring the entire shimming set, which may be incorrect, or the rated value shown on each shim.

Rotating shaft seals

For correct rotating shaft seal installation, proceed as follows:

1. Before assembly, allow the seal to soak in the oil it will be sealing for at least thirty minutes.
2. Thoroughly clean the shaft and check that the working surface on the shaft is not damaged.
3. Position the sealing lip facing the fluid.

NOTE: *With hydrodynamic lips, take into consideration the shaft rotation direction and position the grooves so that they will move the fluid towards the inner side of the seal.*

4. Coat the sealing lip with a thin layer of lubricant (use oil rather than grease). Fill the gap between the sealing lip and the dust lip on double lip seals with grease.
5. Insert the seal in its seat and press down using a flat punch or seal installation tool. Do not tap the seal with a hammer or mallet.
6. While you insert the seal, check that the seal is perpendicular to the seat. When the seal settles, make sure that the seal makes contact with the thrust element, if required.
7. To prevent damage to the seal lip on the shaft, position a protective guard during installation operations.

O-ring seals

Lubricate the O-ring seals before you insert them in the seats. This will prevent the O-ring seals from overturning and twisting, which would jeopardize sealing efficiency.

Sealing compounds

Apply a sealing compound on the mating surfaces when specified by the procedure. Before you apply the sealing compound, prepare the surfaces as directed by the product container.

Spare parts

Only use CNH Original Parts or NEW HOLLAND Original Parts.

Only genuine spare parts guarantee the same quality, duration, and safety as original parts, as they are the same parts that are assembled during standard production. Only CNH Original Parts or NEW HOLLAND Original Parts can offer this guarantee.

When ordering spare parts, always provide the following information:

- Machine model (commercial name) and Product Identification Number (PIN)
- Part number of the ordered part, which can be found in the parts catalog

Protecting the electronic and/or electrical systems during charging and welding

To avoid damage to the electronic and/or electrical systems, always observe the following practices:

1. Never make or break any of the charging circuit connections when the engine is running, including the battery connections.
2. Never short any of the charging components to ground.
3. Always disconnect the ground cable from the battery before arc welding on the machine or on any machine attachment.
 - Position the welder ground clamp as close to the welding area as possible.
 - If you weld in close proximity to a computer module, then you should remove the module from the machine.
 - Never allow welding cables to lie on, near, or across any electrical wiring or electronic component while you weld.
4. Always disconnect the negative cable from the battery when charging the battery in the machine with a battery charger.

NOTICE: *If you must weld on the unit, you must disconnect the battery ground cable from the machine battery. The electronic monitoring system and charging system will be damaged if this is not done.*

5. Remove the battery ground cable. Reconnect the cable when you complete welding.

WARNING

Battery acid causes burns. Batteries contain sulfuric acid.

Avoid contact with skin, eyes or clothing. Antidote (external): Flush with water. Antidote (eyes): flush with water for 15 minutes and seek medical attention immediately. Antidote (internal): Drink large quantities of water or milk. Do not induce vomiting. Seek medical attention immediately. Failure to comply could result in death or serious injury.

W0111A

Special tools

The special tools that NEW HOLLAND suggests and illustrate in this manual have been specifically researched and designed for use with NEW HOLLAND machines. The special tools are essential for reliable repair operations. The special tools are accurately built and rigorously tested to offer efficient and long-lasting operation.

By using these tools, repair personnel will benefit from:

- Operating in optimal technical conditions
- Obtaining the best results
- Saving time and effort
- Working in safe conditions

Torque

Minimum hardware tightening torques (in N m or lb in /lb ft) for normal assembly applications unless otherwise stated

NOTICE: Shown below is the suggested initial torque tightening sequences for general applications, tighten in sequence from item 1 through to the last item of the hardware.

The minimum hardware tightening torque on drawings, in specifications etc. have priority.
The applicable CNH Standard is ENS7001.

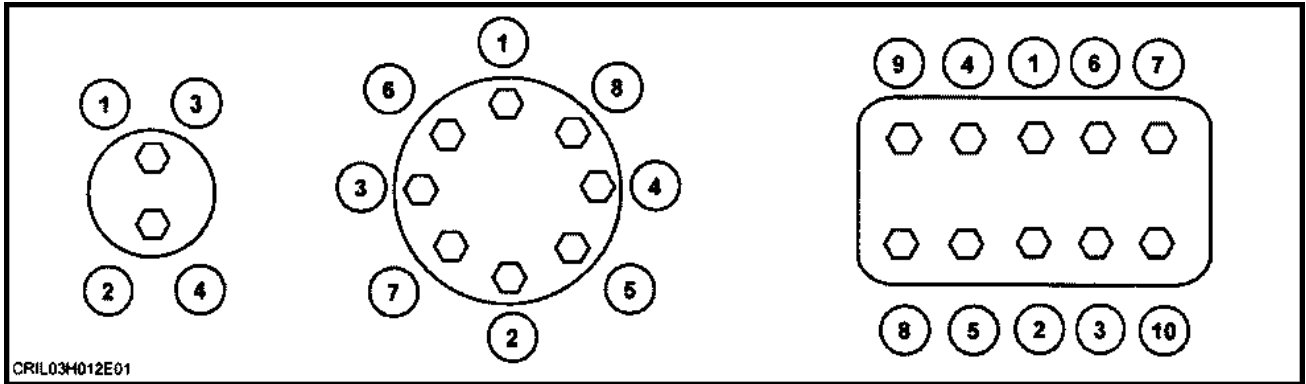

DF5019-1 1

Metric hardware

Nominal Size	Class 8.8 in N m (lb in or lb ft)			Class 10.9 in N m (lb in or lb ft)		
	Plated nut	Lock nut	Hardened nut	Plated nut	Lock nut	Hardened nut
M3	1.3 N·m (11.5 lb in)	0.7 N·m (6.2 lb in)	1.2 N·m (10.6 lb in)	1.8 N·m (15.9 lb in)	0.9 N·m (8.0 lb in)	1.6 N·m (14.2 lb in)
M4	2.9 N·m (25.7 lb in)	1.6 N·m (14.2 lb in)	2.6 N·m (23.0 lb in)	4.2 N·m (37.2 lb in)	2.3 N·m (20.4 lb in)	3.7 N·m (32.7 lb in)
M5	5.9 N·m (52.2 lb in)	3.2 N·m (28.3 lb in)	5.3 N·m (46.9 lb in)	8.5 N·m (75.2 lb in)	4.6 N·m (40.7 lb in)	7.6 N·m (67.3 lb in)
M6	10.1 N·m (89.4 lb in)	5.5 N·m (48.7 lb in)	9.1 N·m (80.5 lb in)	14.5 N·m (10.7 lb ft)	7.9 N·m (69.9 lb in)	13 N·m (9.6 lb ft)
M8	24.5 N·m (18.1 lb ft)	13.5 N·m (10.0 lb ft)	22 N·m (16.2 lb ft)	35.1 N·m (25.9 lb ft)	19.3 N·m (14.2 lb ft)	31.5 N·m (23.2 lb ft)
M10	48.7 N·m (35.9 lb ft)	26.8 N·m (19.8 lb ft)	43.8 N·m (32.3 lb ft)	69.5 N·m (51.3 lb ft)	38.2 N·m (28.2 lb ft)	62.5 N·m (46.1 lb ft)
M12	85 N·m (62.7 lb ft)	46.7 N·m (34.4 lb ft)	76.5 N·m (56.4 lb ft)	121 N·m (89.2 lb ft)	66.5 N·m (49.0 lb ft)	108.9 N·m (80.3 lb ft)
M14	135 N·m (99.6 lb ft)	74.2 N·m (54.7 lb ft)	121.5 N·m (89.6 lb ft)	193 N·m (142.3 lb ft)	106.1 N·m (78.3 lb ft)	173.7 N·m (128.1 lb ft)
M16	210 N·m (154.9 lb ft)	115.5 N·m (85.2 lb ft)	189 N·m (139.4 lb ft)	301 N·m (222 lb ft)	165.5 N·m (122.1 lb ft)	270.9 N·m (199.8 lb ft)
M18	299 N·m (220.5 lb ft)	164.4 N·m (121.3 lb ft)	269.1 N·m (198.5 lb ft)	414 N·m (305.4 lb ft)	227.7 N·m (167.9 lb ft)	372.6 N·m (274.8 lb ft)
M20	425 N·m (313.5 lb ft)	233.72 N·m (172.4 lb ft)	382.5 N·m (282.1 lb ft)	587 N·m (432.9 lb ft)	322.8 N·m (238.1 lb ft)	528.3 N·m (389.7 lb ft)
M22	579 N·m (427 lb ft)	318.4 N·m (234.8 lb ft)	521.1 N·m (384.3 lb ft)	801 N·m (590.8 lb ft)	440.5 N·m (324.9 lb ft)	720.9 N·m (531.7 lb ft)
M24	735 N·m (542.1 lb ft)	404.2 N·m (298.1 lb ft)	661.5 N·m (487.9 lb ft)	1016 N·m (749.4 lb ft)	558.8 N·m (412.1 lb ft)	914.4 N·m (674.4 lb ft)
M27	1073 N·m (791.4 lb ft)	590.1 N·m (435.2 lb ft)	967.5 N·m (713.6 lb ft)	1486 N·m (1096 lb ft)	817.3 N·m (602.8 lb ft)	1337 N·m (986.1 lb ft)
M30	1461 N·m (1077.6 lb ft)	803.5 N·m (592.6 lb ft)	1315 N·m (969.9 lb ft)	2020 N·m (1489.9 lb ft)	1111 N·m (819.4 lb ft)	1818 N·m (1340.9 lb ft)

**IDENTIFICATION
HEX CAP SCREW AND CARRIAGE BOLTS**



LOCKNUTS

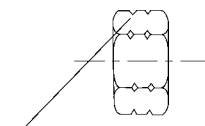

GRADE IDENTIFICATION
 GRADE A: NO NOTCHES
 GRADE B: ONE CIRCUMFERENTIAL NOTCH
 GRADE C: TWO CIRCUMFERENTIAL NOTCHES

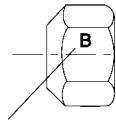

GRADE IDENTIFICATION
 GRADE A: NO MARK
 GRADE B: LETTER B
 GRADE C: LETTER C

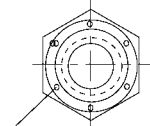

GRADE IDENTIFICATION
 GRADE A: NO MARKS
 GRADE B: THREE MARKS
 GRADE C: SIX MARKS

ZEIL06CS0136F0A

ZEIL06CS0136F0A 2

**IDENTIFICATION
HEX CAP SCREW AND CARRIAGE BOLTS
CLASSES 5,6 AND UP**

MANUFACTURER'S IDENTIFICATION

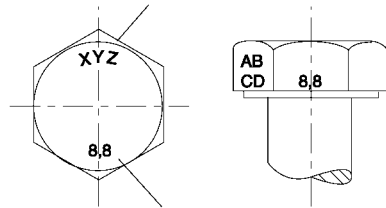

PROPERTY CLASS

**HEX NUTS AND LOCKNUTS
CLASSES 05 AND UP**

MANUFACTURER'S IDENTIFICATION

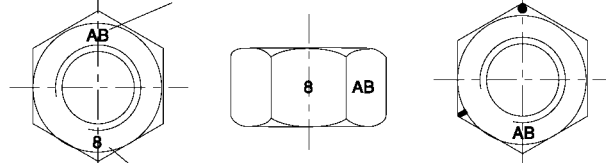

PROPERTY CLASS

CLOCK MARKING

ZEIL06CS0135F0A

ZEIL06CS0135F0A 3

**Thanks very much for your reading,
Want to get more information,
Please click here, Then get the complete
manual**

JustClickHere 

NOTE:

**If there is no response to click on the link above,
please download the PDF document first, and then
click on it.**

**Have any questions please write to me:
admin@servicemanualperfect.com**